

Robert Sorby

ProEdge

The Ultimate Sharpening System

For all your sharpening needs

- Patented angle setter guarantees repeatability
- Quick change abrasive belts for speed and accuracy
- Pivots for operator comfort
- Sharpening accessories and kits available



MADE IN BRITAIN

MADE IN SHEFFIELD

PROUDLY MADE IN SHEFFIELD, ENGLAND

INSTRUCTION MANUAL

ProEdge

The Robert Sorby ProEdge Sharpening System

Thank you for purchasing the **Robert Sorby ProEdge** sharpening system, it has been designed using hundreds of years of tool manufacturing experience.

The simple set-up and operation of the **ProEdge** makes sharpening tools a pleasure and gives the woodworker great satisfaction in achieving a perfect sharp edge every time.

EC DECLARATION OF CONFORMITY

Business Name & Address Of Responsible Person:

- Robert Sorby, Atlas Way, Atlas North, Sheffield S4 7QQ England.

Capacity /Role of Responsible Person:

- Manufacturer

Description of Machine:

- ProEdge Sharpening System

Serial Number:

- Affixed to machine and box

Relevant EC Directives & Regulations Complied with for Above Machine:

- Supply of Machinery (Safety) Regulations 1992 - Amended 1994: Machinery Directive 98/37 /EEC

Relevant EC Transposed Harmonised Standards

- BS.EN 1050; BS.EN 292; (ISO14121); BS.EN 953;

National Standards Used:

- BS.EN 5304 - Safety of Machinery

DECLARATION:

I certify that on completion of manufacture of the machine detailed above that a full conformity assessment has been completed and relevant essential health & safety requirements complied with:

Name: Duncan Horton

Status within Company: General Manager/Director



**THESE INSTRUCTIONS MUST BE READ AND UNDERSTOOD BEFORE
OPERATING THE MACHINE**



WARNING



GROUNDING INSTRUCTIONS

All grounded, cord-connected tools:

In the event of a malfunction or breakdown, grounding provides a path of least resistance for electric current to reduce the risk of electric shock. This tool is equipped with an electric cord having an equipment grounding conductor and a grounding plug. The plug must be plugged into matching outlet that is properly installed and grounded in accordance with all local codes and ordinances.

Do not modify the plug provided - if it will not fit the outlet, have the proper outlet installed by a qualified electrician.

Improper connection of the equipment-grounding conductor can result in a risk of electric shock. The conductor with insulation having an outer surface that is green with or without yellow stripes is the equipment-grounding conductor. If repair or replacement of the electric cord or plug is necessary, do not connect the equipment grounding conductor to a live terminal.

Check with a qualified electrician or service personnel if the grounding instructions are not completely understood, or if in doubt as to which outlets and 3-pole receptacles that accept the tool's plug. Repair or replace damaged or worn cord immediately.

- **RISK OF INJURY DUE TO ACCIDENTAL STARTING** - Do not use in an area where children may be present
- **KEEP GUARDS IN PLACE** and in working order
- **REMOVE ADJUSTING KEYS AND WRENCHES.** Form the habit of checking to see that keys and wrenches are removed from the tool before turning it on
- **KEEP WORK AREA CLEAN.** Cluttered areas and benches invite accidents
- **DON'T USE IN DANGEROUS ENVIRONMENT.** Don't use power tools in damp or wet locations, or expose them to rain. Keep work area well lit
- **KEEP CHILDREN AWAY.** All visitors, especially children, should be kept a safe distance from work area
- **MAKE WORKSHOP CHILD PROOF** with padlocks, master switches, or by removing starter keys
- **DON'T FORCE THE TOOL.** It will do the job better and safer at the rate for which it was designed
- **USE THE RIGHT TOOL.** Don't force tool or attachment to do a job for which it was not designed
- **USE PROPER EXTENSION CORD.** Make sure your extension cord is in good condition. When using an extension cord, be sure to use one heavy enough to carry the current your product will draw. An undersized cord will cause a drop in line voltage resulting in loss of power and overheating

Table 1 - Minimum gauge for cord

Ampere Rating		Volts	Total length of cord in feet			
			25 ft.	50 ft.	100 ft.	150 ft.
		120 V				
		240 V	50 ft.	100 ft.	200 ft.	300 ft.
More Than	Not More Than	AWG (American Wire Gauge)				
0	6		18	16	16	14
6	10		18	16	14	12
10	12		16	16	14	12
12	16		14	12	Not Recommended	

*Table 1 shows the correct size to use depending on cord length and nameplate ampere rating. If in doubt, use the next heavier gauge. The smaller the gauge number the heavier the cord.



WARNING



WEAR PROPER APPAREL. Do not wear loose clothing, necktie's, rings, bracelets, or other jewellery which may get caught in moving parts. Non-slip footwear is recommended. Wear protective hair covering to contain hair.

ALWAYS USE SAFETY GLASSES. Also use face or dust mask if cutting operation is dusty. Everyday eyeglasses only have impact resistant lenses, they are NOT safety glasses.

- **SECURE WORK.** Use clamps or a vice to hold work when practical. It's safer than using your hand and it frees both hands to operate tool
- **DON'T OVERREACH.** Keep proper footing and balance at all times
- **MAINTAIN TOOLS WITH CARE.** Keep tools sharp and clean for best and safest performance. Follow instructions for lubricating and changing accessories
- **DISCONNECT TOOLS** before servicing: when changing accessories and belts
- **REDUCE THE RISK OF UNINTENTIONAL STARTING.** Make sure switch is in 'off' position before plugging in
- **USE RECOMMENDED ACCESSORIES.** Consult the owner's

manual for recommended accessories. The use of improper accessories may cause risk of injury to persons

- **NEVER STAND ON THE TOOL.** Serious injury could occur
- **CHECK DAMAGED PARTS.** Before further use of the tool, a guard or other part that is damaged should be carefully checked to determine that it will operate properly and perform its intended function - check for alignment of moving parts, binding of moving parts, breakage of parts, mounting, and any other conditions that may affect its operation. A guard or other part that is damaged should be properly repaired or replaced
- **NEVER LEAVE TOOL RUNNING UNATTENDED.**
TURN POWER OFF. Don't leave tool until it comes to a complete stop

RESIDUAL HAZARDS

1. Friction and abrasion arising from contact with the belt surface at the point where it is exposed for use.

Precaution - no further enclosure is deemed to be practicable and therefore the appropriate guides should be used when completing the sharpening operation and, furthermore, care should be exercised by adopting safe working practice.

2. Trap point in-between the belt and pulley.

Precaution - the side guard is fixed in position on delivery. This must always be replaced prior to use whenever belts are changed.

During the belt changing operation, the machine should be disconnected from the electrical supply with full isolation being retained until the guard is affixed.

The moulded plastic retaining nuts must always be replaced prior to usage.

3. Machines moving or toppling over during usage.

Precaution - secure the machine to the workbench utilising the four holes in the base plate.

4. Ejection hazards. Small particles may be ejected from the belt and the tool during the sharpening operation or in the unlikely event of the belt breaking during usage.

Precaution - wear suitable approved eye protection during usage.

5. Entanglement with buffing and polishing attachments. Precaution - remove jewellery and watches and avoid loose clothing.

6. Inhalation of dust arising from the abrasive coating on the belt and the tool being sharpened.

Precautions - the normal usage of the **ProEdge** is such that it is highly unlikely that the dust hazard would become a health risk. Notwithstanding this, repeated and consistent use may lead to significant volumes of dust arising and it is therefore recommended that for high levels of usage, the machines should be connected to an appropriate local exhaust ventilation system (LEV) via the port at the bottom of the existing enclosure guard. Should the machine not be fitted to an LEV, an appropriate cover plate should be fitted over the aperture.

Suitable EC approved (or equivalent) respiratory protection (dust mask) should be worn when grinding tools.

7. Manual handling - each ProEdge weighs approximately 31lbs (14kg). Precaution - Care should be exercised when lifting.

ProEdge

Technical Details

Motor: 1/2hp Belt Width: 2" Belt Speed 1400ft (440m) per minute to achieve the best results from your system, please familiarise yourself with all of its parts and accessories.

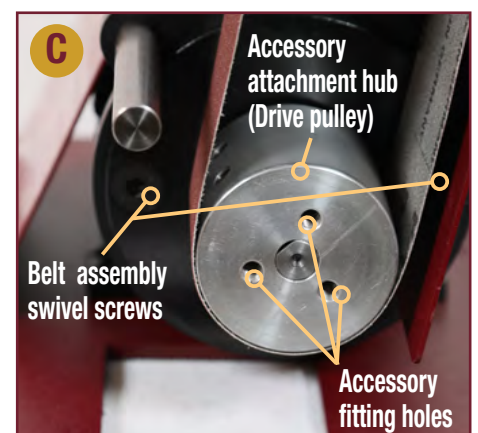
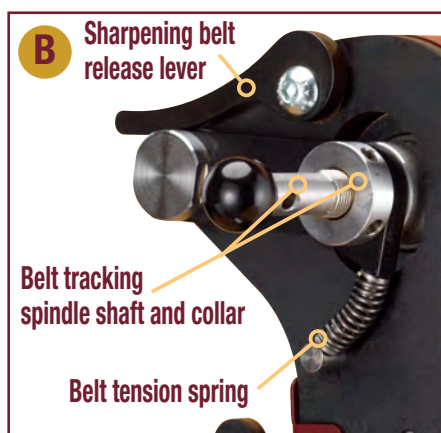
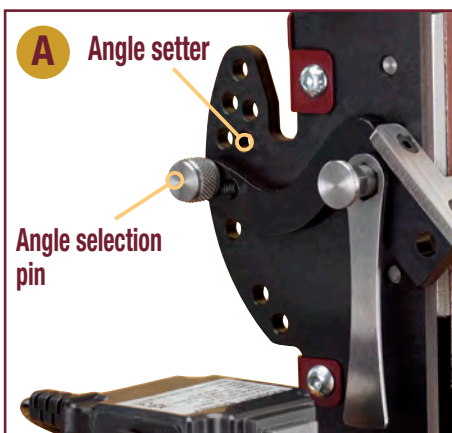
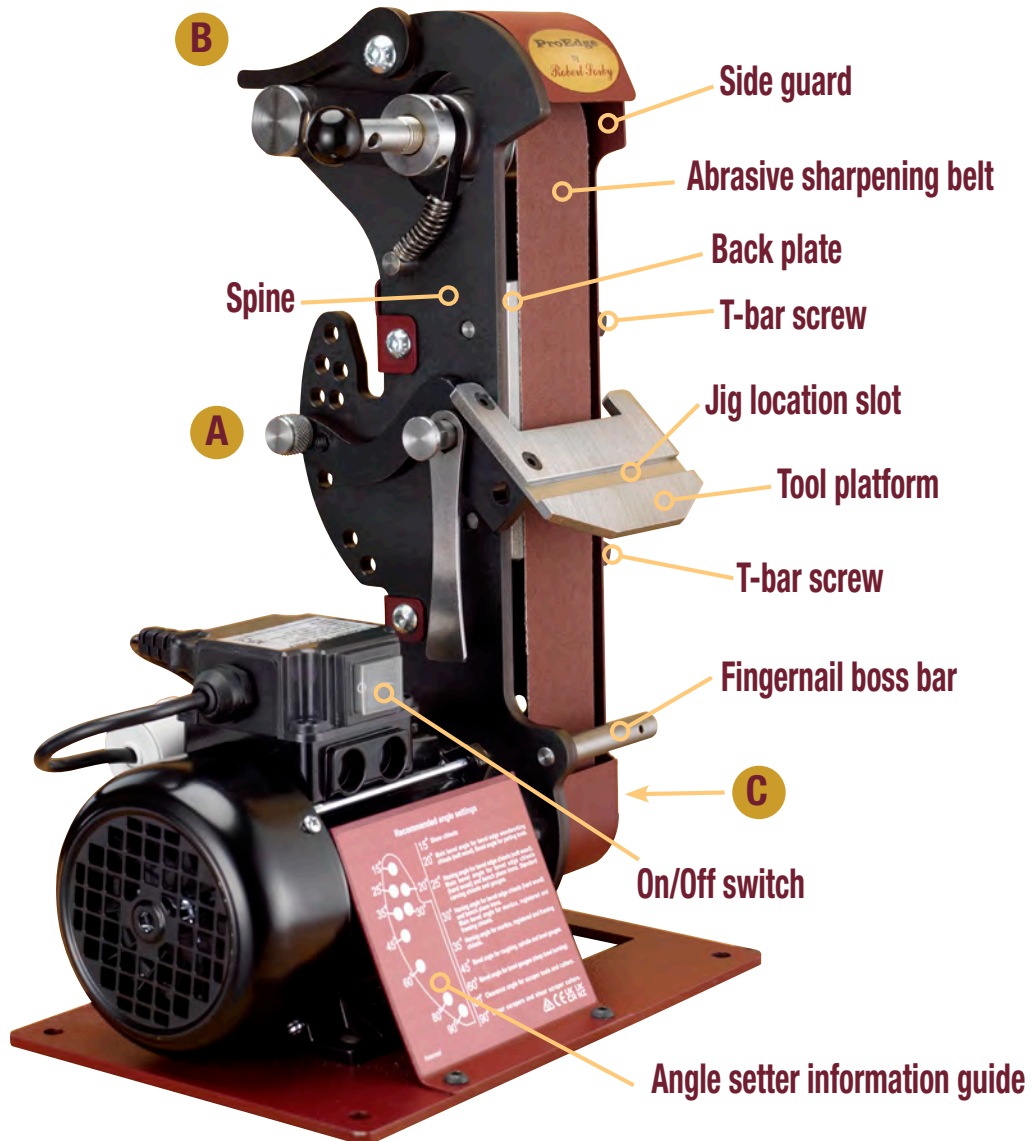

ProEdge

Preparing for use

Using the Angle Setter

The unique Angle Setter allows the large tool platform to be set at any angle.

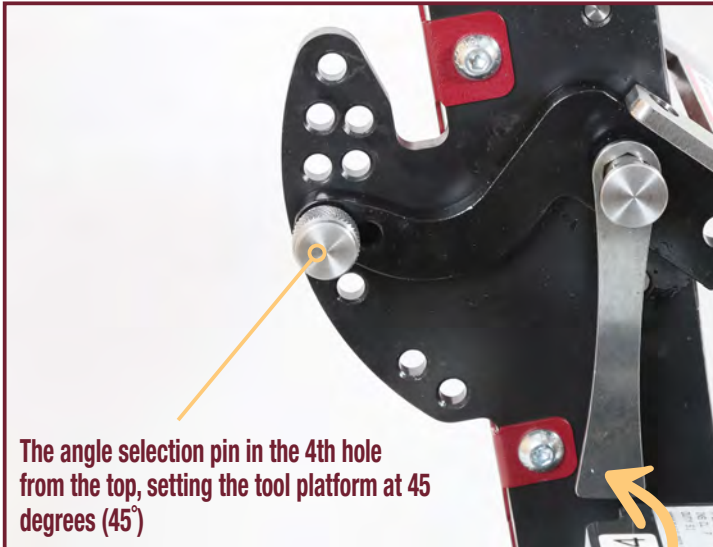

The angle selection pin in the 4th hole from the top, setting the tool platform at 45 degrees (45°)



If a pre-set angle is required, for example 45 degrees (45°), place the captive spanner over the hexagonal locking bolt and loosen. Then loosen the angle selection pin and move the arm so that the selection pin locates into the 4th hole down from the top, as shown on the Angle Setter guide.

If a non pre-set angle is required, wind the angle location pin back so that it is clear of the location holes. Then position the tool platform where it is required and tighten the locking lever.

If you are likely to need to use this position again, use a scribe to mark the table arm position.

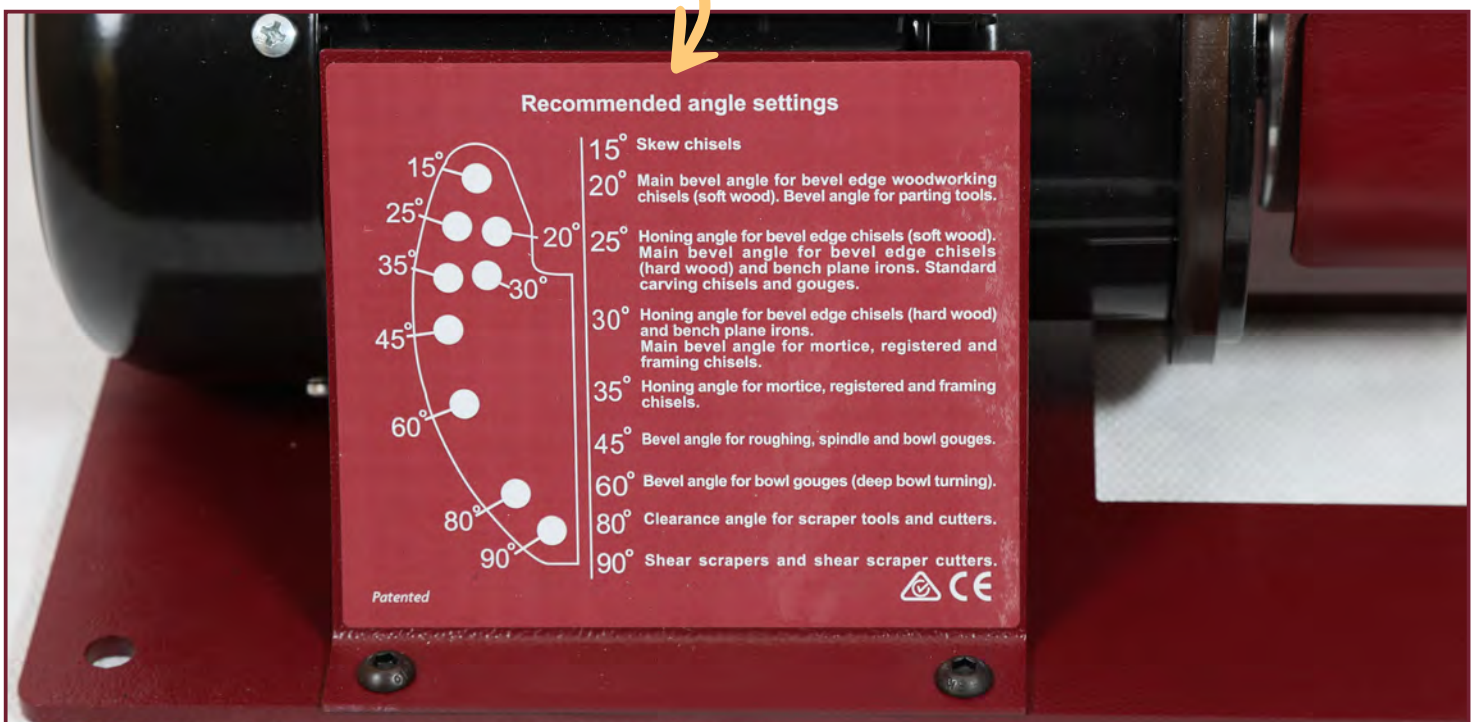

ProEdge

Tilting the Sharpening Belt Assembly

To assist in sharpening tools the ProEdge has a very useful feature in that the sharpening belt assembly can be angled backwards to allow for a much more comfortable position when sharpening at shallow angles.

- This is done by loosening the two screws by a quarter of a turn, next to the drive pulley and gently moving the belt assembly to your desired angle
- When the belt assembly is tilted backwards the rear screw is accessed via the access slot in the side guard as shown below
- When the desired angle is achieved, re-tighten the screws (finger tight) to secure the belt assembly in place



Front screw just below the fingernail boss bar - 1/4 of a turn

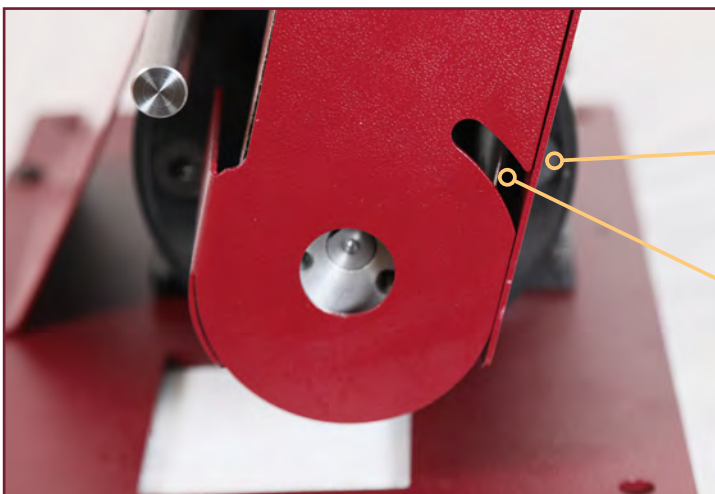
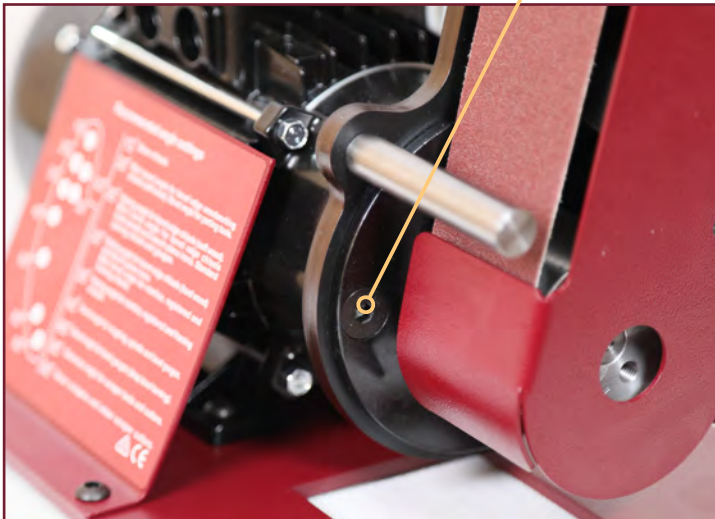

Rear Screw - 1/4 of a turn

Access slot

ProEdge

Jigs, Accessories & Belts

A full list of all the accessories and sharpening belts is on the back page of this booklet. All the accessories are available from Robert Sorby stockists.

Abrasive Belts - Aluminium Oxide, Zirconium, Ceramic, Trizact & Diamond

Aluminium Oxide

Perfect for high Carbon steel tools such as woodworking and carving chisels.

60 grit **WPE60A** 120 grit **WPE120A**
240 grit **WPE240A**

Zirconium

Ideal for High speed steel woodturning tools (HSS).

60 grit **WPE60Z**
120 grit **WPE120Z**

Ceramic

Longer lasting abrasive for High Speed Steel woodturning tools (HSS).

60 grit **WPE60C**
120 grit **WPE120C**

Trizact

Perfect for producing a polished bevel and fine cutting edge on Carbon steel tools.

600 grit **WPE600T** 1200 grit **WPE1200T**
3000 grit **WPE300T**

Diamond

Perfect for retouching the edge on Tungsten Carbide tips and sharpening HSS woodturning tools.

200 grit **WPEDIA**

Woodturning

Fingernail Profile Kit WPEFPKIT



The fingernail profile kit is designed to produce the perfect fingernail profile on bowl and spindle gouges

Long Grind Jig WPELGJ



Allows for fingernail, long grind and extra long grind profiles to be produced on bowl gouges

Standard Gouge Jig WPEVB



Allows for easy sharpening of all standard ground bowl, spindle and roughing gouges

Skew Jig WPEKEW



For quick and easy sharpening of woodturning skew chisels

Cutter Holder W472



Securely holds tips and cutters to allow controlled sharpening

Turnmaster Tip Holder RSTM-TH



Ideal for sharpening TurnMaster tips and cutters

Woodturning

Short Tool Platform WPESPC



A useful table for sharpening tools with short blades

ProSet WPROSET

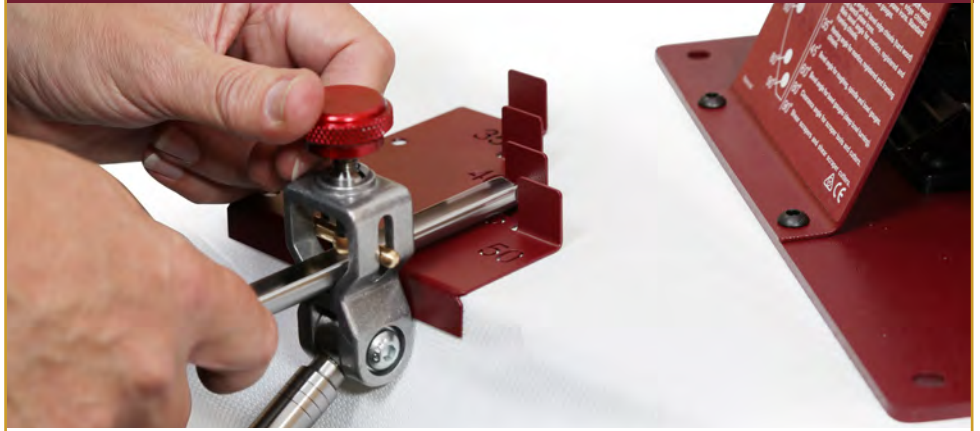

Achieve a consistent bevel angle on any fingernail bowl and spindle gouge when used in conjunction with the fingernail profile arm

Woodworking

Woodworking Chisel Jig WPESQ



Sharpen woodworking chisels with this simple to use jig

Woodworkers Square Guide WPESQW



Accurately sharpen woodworking chisels & plane blades time after time

Knife Sharpening Jigs WPEKJIGS (small) WPEKJIGL (large)



Sharpen a variety of kitchen, garden and hunting knives with these jigs

Carving

Honing Kit WPEHONEKIT



The honing wheel is excellent for woodcarving tools and can be shaped to allow honing of gouge flutes

Polishing

Buffing Kit WPEBUFFKIT



The combination of the honing paste on the buffing mop is used to create an ultra-high polish on any steel

ProEdge

Sharpening Accessory Kits

Woodturning Sharpening Accessory Kit (WPEWTKIT)

ProSet (WPROSET)

Helps you achieve the exact bevel angle on any fingernail or long grind gouge when used in conjunction with the fingernail profiling arm.



Fingernail Profile Kit (WPEFPKIT)

The fingernail profiling kit is ideal for shaping a perfect fingernail profile on bowl and spindle gouges.



Skew Jig (WPEskeW)

For accurate sharpening of woodturning skew chisels.



Standard Gouge Jig (WPEVB)

Allows easy sharpening of all standard ground woodturning gouges.

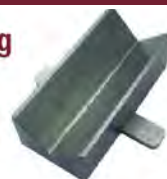

Ceramic Belts

(WPE60C) x1 60 grit
(WPE120C) x1 120 grit

This hardwearing material is a great choice for profiling and re-profiling damaged tools.

60 grit 120 grit



Woodworking Sharpening Accessory Kit (WPEWWKIT)

Woodworkers' Square Guide (WPEsqW)

The square guide raises the tool away from the tool platform. Using a set square or triangle adjust the bar to ensure a perfectly accurate position for sharpening all your chisels and plane blades.



Aluminium Oxide Belt (WPE240A) x1 240 grit

Perfect for high Carbon steel tools such as woodworking and carving chisels.

240 grit



Trizact Belts

(WPE600T) x1 600 grit
(WPE1200T) x1 1200 grit
(WPE3000T) x1 3000 grit

Perfect for producing a polished bevel and fine cutting edge on Carbon steel tools.

600 grit



1200 grit



3000 grit



Knife Sharpening Accessory Kit (WPEKNIFEKIT)

- 1 Raised Wear Platen / Back Plate
- 2 Universal Arm
- 3 Small Knife Holder with angle adjustment collar
- 4 Large Knife Holder with angle adjustment collar
- 5 Allen Key / Wrench



Aluminium Oxide Belts (WPE60A) x1 60 grit (WPE240A) x1 240 grit

Designed primarily to sharpen carbon steel bench chisels, carving tools and plane irons but will also hone harder high speed steel tools.

60 grit



240 grit



Trizact Belts

(WPE600T) x1 600 grit
(WPE1200T) x1 1200 grit
(WPE3000T) x1 3000 grit

Perfect for producing a polished bevel and fine cutting edge on Carbon steel tools.

600 grit



1200 grit



3000 grit



ProEdge

Choosing the Correct Abrasive Sharpening Belt

Abrasive belts cut cleaner and more efficiently than a grinding wheel and will produce a much cleaner cutting edge.

There are five options available to use with the ProEdge system.

-  1. **Aluminium Oxide 60, 120 & 240 grit:** Perfect for high Carbon steel tools such as woodworking and carving chisels
-  2. **Zirconium 60 & 120 grit:** Ideal for High Speed Steel (HSS) woodturning tools
-  3. **Ceramic 60 & 120 grit:** Longer lasting abrasive for High Speed Steel (HSS) woodturning tools
-  4. **Trizact 600, 1200, 3000 grit:** Ideal for producing a polished bevel and fine cutting edge on Carbon steel tools
-  5. **Diamond 200 grit:** Perfect for retouching the edge on Tungsten Carbide tips. Enjoy a longer belt life when sharpening HSS woodturning tools. This belt is washable

Changing a Sharpening Belt

Firstly ensure the electric wall socket is switched off and remove the plug to ensure personal safety.

Remove the two Robert Sorby t-bar screws from the belt assembly and remove the guard.

Lift the belt release lever and pull it towards the front of the system. The belt is now free and can be removed by sliding it off the top and bottom pulleys.

The new belt can now be fitted by sliding it over the two pulleys at the same time, ensuring it is lined up in the centre of both pulleys. Lift the release lever to apply the tension on the belt and return it to its original position at the rear of the system. Replace the side guard and secure in place with the two t-bar screws.

Return the electric plug into the wall socket and switch on. Now switch on the **ProEdge** and check for the belt alignment. If required, the belt can be adjusted as described on page 19.



ProEdge

Using the Accessories

The relevant jigs fit into the slot of the tool platform. This allows the jig to move freely so that all of the sharpening belts can be utilised.

Sharpening a Skew Chisel

The skew chisel needs to be extremely sharp to work correctly and safely, using the **Skew Jig** (WPESKEW) makes this achievable in seconds.

Tilt the belt assembly backwards as instructed on page 6.

Now set the angle setter (page 7) to the top hole 15 degrees (15°) or the desired angle and re-tighten using the locking lever.

The tool platform is now set to the desired angle and the skew jig can be placed as shown.

Ensure there is nothing to obstruct the jig from sliding sideways.

Switch on the **ProEdge** and ensure the belt is aligned correctly. If required, the belt can be adjusted as described on page 19 'Abrasive belt alignment'.

If the belt is correctly aligned, place the skew onto the jig as shown and slowly push the skew chisel forward so that it makes contact with the belt.

Hold the skew chisel against the jig to maintain the correct cutting angle and hold in place. A slight side to side motion can be used but ensure the tool is held securely to the jig.

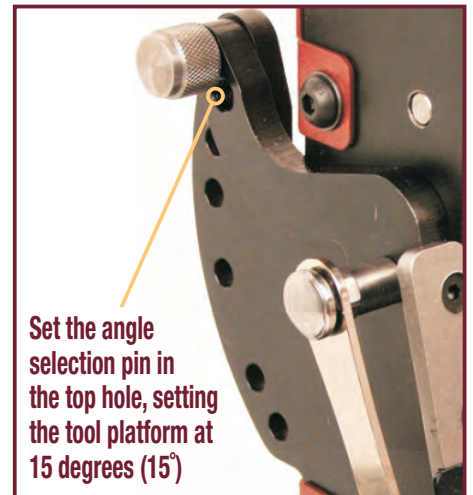

When the first side has been sharpened turn the skew over and place it against the other side of the jig and continue as before, until the tool is razor sharp.



ProEdge

Sharpening Standard Profile Gouges

Keeping a gouge in a consistent position whilst maintaining the required bevel angle takes many hours of practice with a lot of frustration along the way.



The **Standard Gouge Jig** (WPEVB) allows the gouge to sit in the same position and allows it to roll in a constant axis giving a single faced bevel. Set the angle setter to the recommended Robert Sorby 45° for gouge sharpening and lock into place with the locking lever.

Sit the locating key of the block into the slot in the tool platform.

Switch on the **ProEdge** and gently place the gouge into the v-shape of the block. Push the tool up against the abrasive belt and slowly roll it from one side to the other to produce a perfect profile.

Sharpening Woodworking Chisels & Plane Blades

Used in conjunction with the very fine abrasive sharpening belts, the **Woodworkers' Square Guide** (WPESQW) will give a perfect cutting edge on any woodworking chisel and plane blade.



The Angle Setter has all the recommended bevel angles, depending on the wood being used, for woodworking chisels such as bevel edge, paring and framing chisels.

Ensure that the desired sharpening belt is fitted, the angle setter is set to the required angle and tighten the locking bolt.

Check that the slot in the tool rest is clean and place the key of the straight edge jig into it. Switch on the **ProEdge** and carefully place the tool to be sharpened against the guide bar of the jig.

Hold the blade against the jig and carefully push the tool forward until the bevel makes contact with the sharpening belt. A slight side to side motion can be used.

Woodworking Chisel & Plane Blade Bevel Angles

The diagrams below show all the views as described above but with the addition of the two showing the primary and secondary bevel angles depending on the type of wood to be worked.

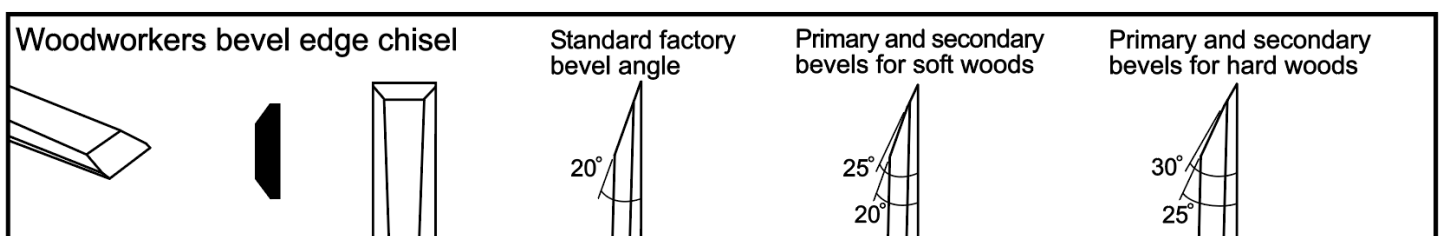

Please refer to the angle setter information guide on the front of the system for more recommended bevel angles.

ProEdge

Sharpening Fingernail Profile Bowl & Spindle Gouges

Sharpening a fingernail profile bowl or spindle gouge can be one of the most difficult jobs for any woodturner.

The **Fingernail Profile Kit** (WPEFPKIT) will produce a fingernail profile on any spindle or bowl gouge from a 1/4" (6mm) to 3/4" (19mm) and it allows for many combinations of bevel angle and wing sweep to be readily achieved.

Fingernail Profile Kit contains the arm and the boss but both items are available individually.



Slide the boss over the fingernail boss bar and place the arm into the location hole. The arm is factory set at 120 degrees (120°) to give the standard Rober Sorby fingernail profile.

To produce a fingernail profile, slide the gouge into the clamp until the bevel is flat against the abrasive belt. Tighten the clamp screw to hold the gouge in place and allow the gouge to move away from the belt prior to switching on the **ProEdge**.

If a different bevel angle is required it is just a matter of sliding the tool further through the clamp and more material will be taken from the heel of the tool making the bevel angle shallower. If a steeper bevel angle is required then the tool needs to be drawn back in the clamp so that more material is removed from the nose.

When the correct angle has been established, switch on the system and move the gouge forward so that one wing touches the abrasive belt.

Holding the tool against the belt, allow the gouge to roll with the arm to produce the fingernail profile with a perfect cutting edge.

ProSet - Bevel Angle Setter Guide

Achieving the exact bevel angle on any fingernail or long grind gouge has never been easier than with the ProSet (WPROSET).

By placing the gouge into the clamp of the profile arm and then extending the gouge upto the required stop and locking it into place the turner will be able to obtain precise and repeatable bevel angles.

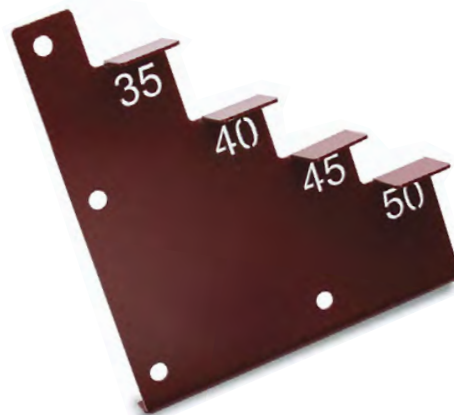

ProEdge

Sharpening Cutters & Tips

To sharpen a tool cutter is normally done using a diamond file or honing stone across the top face. This is a simple and convenient way to maintain a good cutting edge while keeping the cutter attached to its respective tool.

Using the **ProEdge** and the **Cutter Holder** (W472), allows cutters from the Robert Sorby Multi-tipped Hollowing tool (RS200KT), the Hollowmaster (RS230KT) and the Micro Shear Scraper (868H) to be sharpened around the profile, giving a consistent crisp edge whilst maintaining the original shape of the cutter. It also can be used to re-profile cutters and tips to a preferred shape.

At one end of the cutter holder there is a screw in a finger shape to allow different cutters to be held and the finger shape allows for all round access of the profile of the teardrop cutter (RS200C) and the small teardrop (RS222).

In the other end is a clamp to hold hollowing cutters from the Robert Sorby Multi-tipped Hollowing tool (RS200KT) and the Hollowmaster (RS230KT).

Teardrop cutters



Hollowing cutters



Sharpening Cutters using the Cutter Holder

Lay the cutter to be sharpened flat onto the top face of the holder or into the clamp and secure in place with the screw. Set the angle location pin on the Angle Setter to the desired position and tighten the tool platform locking lever. Slowly push the cutting edge up to the belt and carefully follow the profile of the cutter until the desired edge is achieved. For Turnmaster cutters use the RSTM-TH Tip Holder.



Clamp screw

Using the Clamp

Place the cutter into the clamp and secure by tightening the screw. Set the Angle Selection pin into the second from last hole at the bottom which will give 80 degrees (80°) and tighten the platform locking lever to secure. Switch on the **ProEdge** and lay the cutter holder flat onto the platform and slowly push the cutting edge up to the abrasive belt and carefully follow the profile of the cutter.



ProEdge

Sharpening Small & Short Bladed Tools with the Short Tool Platform

The Short Tool Platform (WPESPC) allows for small tools like the micro range and short bladed tools such as many of the carving tools to be sharpened on the ProEdge.

To use the Short Tool Platform the original Tool Platform must be removed by completely unscrewing the locking lever and screw. Now place the locking lever and screw into the hole in the arm of the Short Platform Tool and tighten to hold the platform in place. Also, unscrew the locating pin from the original arm and screw it into the hole in the Short Tool Platform arm to use the angle setter.

The Short Tool Platform can now be adjusted to the desired angle in the same way as the standard tool platform.



Long Grind Jig

Using the Long Grind Jig (WPELGJ) on the fingernail profiler allows for three different types of profile to be produced on bowl and spindle gouges.

It will produce a fingernail profile, a long grind and an extra long grind depending on which location hole the profiling arm is placed in.

It replaces the standard boss which is supplied with the fingernail profile kit.

Woodturning Tool Bevel & Clearance Angles

The diagrams on this page show details of the angles and profiles supplied on Robert Sorby tools. The images are broken into four sections from left to right.

- 1 A general view
- 2 An end view showing the actual cutting edge profile
- 3 A top view showing the shape of the cutting edge as seen when using the tool, together with any relevant profile angle
- 4 A side view with the recommended bevel or clearance angle depending on the type of tool being sharpened

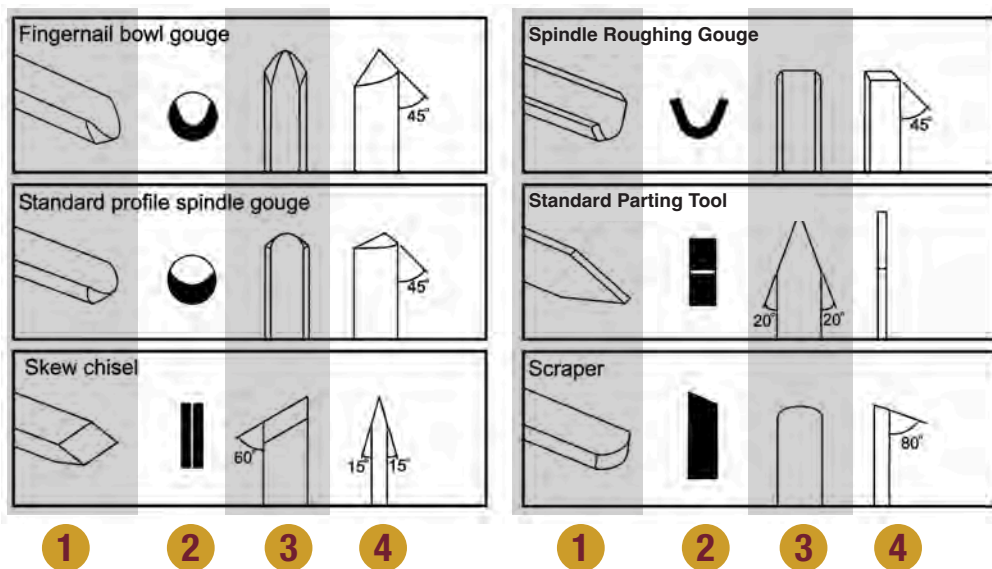

ProEdge

Honing Tools

SAFETY - The abrasive belt should be removed (see page 11) before using the honing wheel to reduce the number of moving parts. Ensure the electric wall socket is switched off to ensure personal safety.

Ideal for honing the bevels and flutes of carving chisels and many other tools, the rubberised abrasive honing wheel (WPEBOND) can be shaped to suit the tool to be sharpened.

Fitting the Arbour & Wheel

Undo and remove the two t-bar screws and remove the side guard from the belt assembly then remove the belt as described on page 11.

Place the arbour against the accessory hub and secure with the three screws. Remove the nut, and replace the side guard and two t-bar screws, place the wheel over the arbour and replace the nut securing the wheel up to the shoulder.

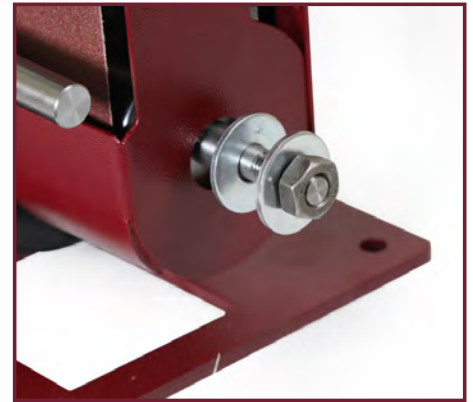

Using the Honing Wheel (WPEHONEKIT)

The outside face and the outer diameter of the wheel can be used to achieve the high polish that is required. As the wheel is manufactured in a rubber compound it is easy to shape the edge using a wheel dresser or abrasive paper such as the 60 grit belts from the **ProEdge**. This is ideal for honing the flutes of gouges.

When sharpening tools on the outside diameter ensure that the cutting edge is facing away from the direction of rotation so it is recommended that the tool is underneath the wheel - fig (a). When using the face of the wheel to flat hone the bevel of any tool always use the same area to avoid the tool cutting edge digging into the wheel.

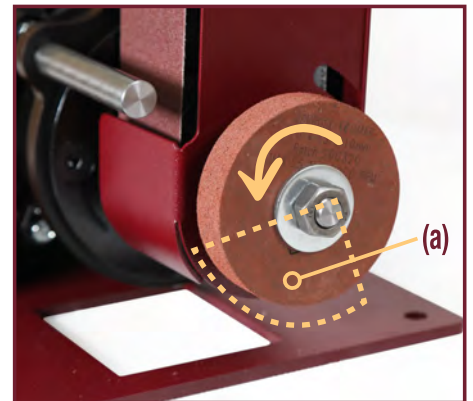

How to adjust the Belt Alignment

While the system is running, place the two tracking adjustment bars into the holes in the spindle shaft and the locking collar. **Hold the shaft stationary and slacken the locking collar (anti-clockwise) prior to moving the tracking shaft.** Small adjustments of the tracking shaft will move the belt to the left and right on the pulley.

Please ensure the belt is tracked to the right hand edge of the backplate.



ProEdge

Polishing Tools & Wooden Projects

SAFETY - The abrasive belt should be removed (see page 11) before using the buffing mop to reduce moving parts. Ensure the electric wall socket is switched off and the plug is removed to ensure personal safety.

Fitting the Pigtail Mandrel and Mop (WPEBUFFKIT)

Unscrew and remove the two t-bar screws and remove the side guard from the belt assembly, then remove the belt as described on page 11. Place the mandrel against the accessory hub and secure with the three screws. Replace the side guard and the two t-bar screws. The mop has a thick leather washer on one side and a fibre washer on the other holding the loose leaves together.

Screw the leather washer side onto the mandrel to ensure a good tight fit.

The blue honing paste contains a variety of materials within it and is specifically designed to give a highly polished cutting edge to Carbon Steel and High Speed Steel tools. When applying the honing or other polishing compound and also when using the mop, always use the area highlighted - fig (a), so that the direction of rotation is away from you.

Apply the buffing paste little and often.

Replace the electric plug into the wall socket, switch on the power and switch on the **ProEdge**.

Apply a small amount of honing paste to the mop as mentioned above, now the tool can be polished. Maintaining a good hold of the tool, apply a light pressure onto the mop with the tool, so that the mop does not displace too much and gently move around the mop to ensure the desired effect.

The mop can also be used to polish wooden projects using the appropriate wax or oil.

SAFETY - Please remove the cotton buffing mop when using the abrasive belt due to the potential fire risk from sparks.

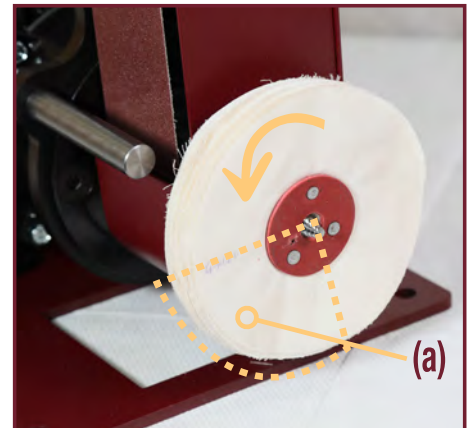
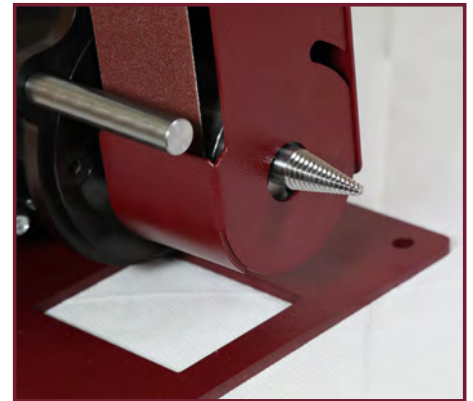

ProEdge

The Robert Sorby Knife Sharpening Jig

The Robert Sorby Knife Sharpening Jigs (Small PEKJIGS & Large PEKJIGL) will enable the sharpening of carving, hunting, pocket and everyday kitchen knives.

There are two models available each consisting of a new back plate with a raised wear plate attached, a universal arm and a choice of either a small or a large knife holder.

The small one (WPEKJIGS) will hold knives upto 8" and the large (WPEKJIGL) will hold blades over 8". Instructions included.

The jig can be easily fitted to the **ProEdge** in a matter of minutes and the only equipment needed is a 13mm wrench/spanner.

The versatility of the two different knife holders means that many types of knife can be brought back to life quickly and easily using this system.

Once the blade is clamped into the holder the knife is gently drawn across the surface of the abrasive belt following the desired bevel angle.

The knife holders are interchangeable and are available individually.



Small kit contents



Large kit contents



Sharpening Belt Alignment

Place the front edge of the base plate so that it is level with the leading edge of the worktop or bench. Screw or bolt the base plate in this position.

Ensure the ON/OFF switch is in the **OFF** position and plug into a standard electric wall socket. Check the cable is in a safe position and that all moving parts of the machine are clear of any obstruction.

Switch on the power at the wall socket and switch the system on. Before operating the machine please watch the belt to check for alignment, it has been pre-tracked in the factory but it may have moved during transit.

ProEdge

Parts List

Jigs & Accessories		Sharpening Belts		
Description	Product Code	Description	Grit	Product Code
Skew Jig	WPESKEW	Aluminium Oxide	60	WPE60A
Fingernail Profiler Kit	WPEFPKIT	Aluminium Oxide	120	WPE120A
Standard Gouge Jig	WPEVB	Aluminium Oxide	240	WPE240A
Woodworking Chisel Jig	WPESQ	Zirconium	60	WPE60Z
Woodworkers Square Guide	WPESQW	Zirconium	120	WPE120Z
Pigtail Madrel	WPEPIG	Ceramic	60	WPE60C
Buffing Mop	WPEMOP	Ceramic	120	WPE120C
Wheel Arbor	WPEARBOR	Trizact	600	WPE600T
Honing Wheel	WPEBOND	Trizact	1200	WPE1200T
Cutter Holder	W472	Trizact	3000	WPE3000T
Turnmaster Tip Holder	RSTM-TH	Diamond	200	WPE600T
Honing Paste	W475			
Short Tool Platform	WPESPC	Sharpening Accessory Kits		
Knife Sharpening Jig - Small	WPEKJIGS	Woodturning Sharpening Accessory Kit		WPEWTKIT
Knife Sharpening Jig - Large	WPEKJIGL	Woodworking Sharpening Accessory Kit		WPEWWKIT
Knife Holder - Small	WPEKHS	Knife Sharpening Accessory Kit		WPEKNIFEKIT
Knife Holder - Large	WPEKHL			
Long Grind Jig	WPELGJ			
ProSet	WPROSET			

For all the latest tools and products, visit our website:

www.robert-sorby.co.uk

For more details on additional accessories as well as replacement and additional sharpening belts, contact your local stockist or Robert Sorby.

Robert Sorby
MADE IN SHEFFIELD, ENGLAND - SINCE 1828



Robert Sorby Ltd, Atlas Way, Atlas North, Sheffield S4 7QQ, England.

Tel: +44(0) 114 225 0700 Email: sales@robert-sorby.co.uk



PROUDLY MADE IN SHEFFIELD, ENGLAND

Registered in England: Company No 3464018, Registered office: Atlas Way, Atlas North, Sheffield, S4 7QQ VAT No. GB 172 4019 84

All sizes and dimensions stated are nominal. It is our policy to continuously improve products and hence we reserve the right to change designs without prior notice. E & OE



Patent No. 2438962